

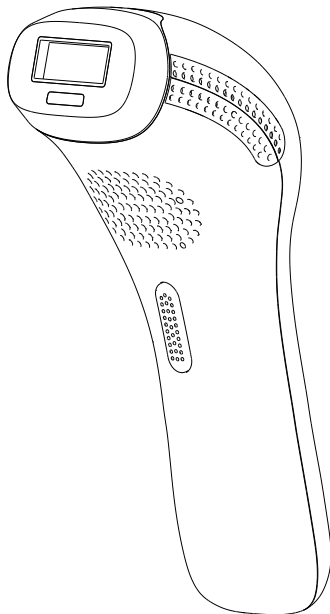

# LOVE MY SKIN

**PREMIUM IPL HAIR  
REMOVAL DEVICE**

INSTRUCTION MANUAL



LMSIPL1

## SAFETY INSTRUCTIONS

---

To ensure proper operation of this device, please read this instruction manual carefully before using the device and keep it for further reference.

### **⚠ WARNING**

- This device is not a toy, keep out of reach of children.
- Please register the device before you start using it (<https://www.love-my-skin.co.uk/warranty/>). Do not use if there is any damage.
- Keep the device and power adapter dry.
- Make sure the device operating voltage complies with the rated voltage of the power source.

### **⚠ CAUTION**

#### **• The following persons should not use this device:**

- Pregnant women or while nursing, or during menstruation; children.
- Your skin is sensitive to light and is prone to develop a rash or allergic reaction.
- Persons with a history of skin diseases, or that are currently been treated for skin related diseases.
- Persons with precancerous lesions or multiple atypical birthmarks (moles) on the areas you want to use the device.
- If the area you want to treat has infections, burns, eczema, hair follicle inflammation, scratches, open wounds, herpes simplex, lacerations or hematomas.
- Persons with a history of collagen disorder, keloid scar formation or difficulty in healing wounds.

- Persons with a history of vascular diseases, such as varicose veins, etc.
  - Persons with diabetes, lupus erythematosus, porphyria, congestive heart disease, and bleeding disorders.
  - Persons who have a history of immunosuppressive disease (including HIV infection and AIDS).
  - If you are receiving or have received in the last couple of months radiotherapy or chemotherapy.
- Do not use this device on the following areas:**
- On areas with hyperpigmentation or hypopigmentation, intense redness, or burns.
  - On areas where you had surgery.
  - Around the eyes and eyebrows to avoid eye injury.
  - On the nipples, areolas, labia minora, vagina, anus, inside the nostril and ears. Men cannot use this device on the scrotum and face.
  - Near silicone implants, pacemakers, subcutaneous injection port (such as insulin dispensers), body piercings. Any artificial surface should be avoided.
  - On moles, freckles, large veins, darker pigmented areas, scars, and skin abnormalities without doctor supervision.
  - On tattoos or permanent makeup, as it can cause burns to the skin and change its pigmentation.
  - On areas where you use long-lasting deodorants, as it may cause skin irritation.
  - Do not use this device on skin with sunburns, recently tanned or false tanned.

- **Do not use this device if you take the following medications or treatments:**
  - Your skin is being treated or has recently been treated with alpha-hydroxy acids (AHAs), beta-hydroxide acids (BHAs), topical isotretinoin and azelaic acid.
  - If you have taken oral or topical Accutane or Roaccutane acid in the past six months. This treatment makes skin more susceptible to lacerations, trauma, and irritation.
  - If you are taking any kind of photosensitizing agent or medication, always verify the patient information leaflet of the medicine, and do not use the device if it is specified that it can cause light allergy reactions, photo-toxic reactions, or if you should avoid sun exposure while taking the medicine.
  - If you are taking anticoagulant medicines, including the use of large quantities of aspirin and cannot stop at least one week before each treatment.
- This device is not intended for use by persons (including children) with reduced physical, or mental capabilities, or lack of experience and knowledge, unless they have been given supervision or instruction concerning the use of the device by a person responsible for their safety.
- Teenagers aged between 15 and 18 years old may use this equipment with the consent and/or assistance of their parents. Adults over 18 years old can freely use this device always following the warnings and using recommendations of this instruction manual.
- Immediately stop using the device and consult a doctor if you feel any discomfort.
- If the device is damaged, do not touch the internal parts to avoid electric shock.
- Do not insert any objects into the device.
- The adapter contains a transformer, do not cut the power converter to replace it with another plug as it is dangerous.
- Do not use the device if the filter of the Light Exit Window is damaged.
- This device cannot be washed. Do not immerse or wash it under running water.
- This device is not suitable to use on children. Keep it out of reach of children.
- Regularly clean the device surface to extend its lifetime.
- Do not attempt to disassemble, repair or modify the device by yourself to avoid accidents.
- Do not place or store the device for a long period in a hot or humid environment. If you do not intend to use the device for a long time, store it in a dry place at room temperature.
- When using this device, ensure you (and other people in the same room) do not look directly into the light exit window to avoid eye discomfort. Always use protective goggles (included) when using the device.
- The warnings list is not exhaustive. If you are not sure whether you can or cannot use this device, please consult a doctor.

## 1. DEVICE SPECIFICATIONS

Name: Premium IPL Hair Removal Device

Model No.: LMSIPL1

Power: 12V  /3A

Power: 36W

## 2. DEVICE DESCRIPTION

1. Light Exit Window
2. Skin Tone Sensor
3. Air Vents
4. Air Entry System
5. Flash Button
6. Flash Ready Light
7. Intensity Indicator
8. Power Button / Intensity Switch
9. Skin Contact Sensor
10. DC Plug-in Port
11. Power Adapter
12. Protective Goggles

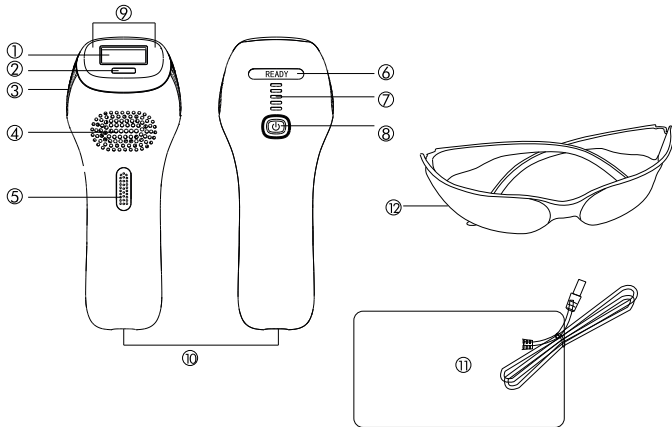

## 3. CERTIFICATION MARKS



(Picture 1)

## 4. PREPARING THE DEVICE

---

✘ Connect one end of the power cord to the product DC plug-in port, and insert the plug into a power socket. (Picture 2)

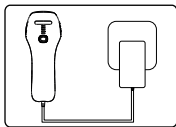

(Picture 2)

## 5. HOW TO USE

---

To ensure the correct operation of this device, please read the instructions carefully before use.

### 5.1 DEVICE OPERATION

---

#### Switch ON:

(1) Plug the power adapter into a wall socket. The intensity indicator lights flash in a cycle, and the device gets in standby mode. Press and hold the power button. The device will switch on at the first intensity level setting with a beeping sound.

(2) If the power adapter is still connected to the wall socket, but the intensity indicator lights are off, the device is still in standby mode. Press and hold the power button to switch on the device.

#### Switch OFF:

Press and hold the power button, the intensity indicator lights will stop flashing, and the device switches off after a beeping sound.

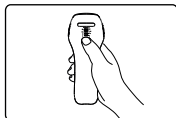

(Picture 3)

- **Intensity Level Adjustment:** With the device ON, press the intensity switch to adjust the treatment intensity level in a cycle - a total of 5 levels. First-time users should start the first session at the lowest intensity level. You can gradually increase the intensity level. (Picture 4)



(Picture 4)

- **Trigger a Flash:** With the device ON, press the light exit window against the area to be treated. If the sensors detect that your skin tone is valid for the intensity level setting chosen, the flash ready light lights up green. Press the flash button to trigger a flash. If the sensors detect that the chosen intensity level is not suitable for your skin tone, or if the sensors are not in full contact with the skin, the READY indicator flashes green. If you press the flash button, it will not trigger a flash.

## 5.2 SKIN TEST PATCH

---

✘ For first-time users, we recommend you to test the device on the arm for reactions. Wait for 24 hours following the test patch to verify if your skin has an adverse reaction to the treatment. If there is no visible reaction, you can use the device.

Turn on the device, select the intensity level 1, place the light exit window on the skin and apply one flash. Afterward, you can increase the intensity to level 2 and apply another flash on the skin. Test all intensity levels on your skin (do not flash multiple times on the same area). After you test the skin, choose the intensity level that did not cause a reaction on your skin.

## 5.3 WHERE TO USE

---

✘ If before using the device you removed hairs by using a long-lasting removing method, such as plucking, waxing, etc., wait until hairs start growing again to use the device.

### • Treatment areas

1. Armpits
2. Bikini area
3. Arms and legs
4. Back

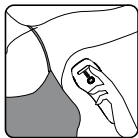

①

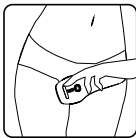

②

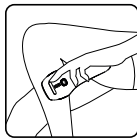

③



④













(Picture 5)

### • Treatment time

According to hair growth cycle, it is recommended to use the IPL Hair Removal Device once every two weeks for the first 3-4 times and gradually reduce the use according to hairs condition.

## SKIN TONE/HAIR COLOR REFERENCE CHART

- ✘ Please refer to the chart below before you start using the device to determine if your skin tone and hair color are suitable to use with the intensity lights (“o” means the device is suitable for you, “X” means the device is not suitable for you, 1-5 refers to the flash intensity levels).
- ✘ If this device is suitable for you, please refer to below chart to select an appropriate light intensity (the device is more effective at a higher intensity light. However, if you feel any pain or discomfort, please reduce the intensity).
- ✘ Darker skin tones absorb more light easily causing skin irritation. Therefore, persons with darker skin tones are recommended to use a lower flash intensity light.

Skin Tone Hair Colour						
	X	X	X	X	X	X
	X	X	X	X	X	X
	X	X	X	X	X	X
	✓ 1/2/3/4/5	✓ 1/2/3	✓ 1/2	X	X	X
	✓ 1/2/3/4/5	✓ 1/2/3/4/5	✓ 1/2/3	✓ 1/2	X	X
	✓ 1/2/3/4/5	✓ 1/2/3/4/5	✓ 1/2/3/4/5	✓ 1/2/3/4	✓ 1/2/3	X

X = Not Safe to Use    ✓ = Safe to Use

## 5.4. HOW TO USE

---

- Before you start using the device, use a razor or trimmer to shave all hairs on the surface of the skin (do not pluck or use chemical hair removal products), completely dry the skin and remove any oily substances (such as body fragrance, lotion, perfume, sunscreen, and other cosmetics).
  - Connect the adapter to a wall socket. Press and hold the power button to turn on the device.
  - Select the appropriate flash intensity for your skin tone and hair color (for first-time users, use the lowest light intensity recommended and adjust it gradually).
  - Wear protective goggles to avoid looking into the light.
  - Place the light exit window on the skin, ensuring the skin contact sensor is fully in contact with the skin. Wait for 1-4 secs, when the flash ready light turns green, press the flash button to apply the flash. You will feel a slight burning sensation (flash light energy being absorbed). If you want to reduce the burning sensation, adjust the intensity level.
  - The device's skin tone sensor automatically detects skin tone for your protection. If your skin tone is not in the range suitable for treatment, the device does not emit the flash. At this moment, you can decrease the flash intensity and follow the above steps to use the device.
  - After use, turn off the device, unplug the adapter, and clean the device.
- ✘ Note: This device has a protection mechanism. When you adjust from intensity 5 to intensity 1 or 2 without pressing the flash button, the READY indicator flashes slightly, and the device cannot flash. Please wait for about 10 seconds before you can use it again.
- ✘ This device features a high-temperature protection system. The protection system is always on when using the highest flash intensity level, and the device will enter standby mode if the temperature is too high (this is normal). You can press the power button to turn on the device again.
- ✘ After using the device, do not apply any fragrant skin care or cosmetic product on your skin.
- ✘ Do not use deodorant immediately after using the device on the armpits. Wait until the skin redness completely disappears to start using deodorant.
- ✘ After each treatment, make sure your skin doesn't show any signs of redness after 24 hours.
- ✘ Keep the treated area covered and away from direct sunlight two weeks after the treatment or use sunscreen (SPF 30+) on the treated area.



## 6. RARE SIDE EFFECTS

---

- **Burns, abnormal redness and swelling**

These reactions are very rare, they may be caused by using a high flash intensity. If these adverse reactions continue for 3 days or more, immediately consult a doctor. Only start the next treatment if the skin is clear of any problem, and make sure you use a lower flash intensity.

- **Skin discoloration**

Normal but very rare. When using the device, the skin may suffer from discoloration, this may happen because you are using a high-intensity flash. When the discoloration disappears, reduce the flash intensity during the next treatments. If the skin discoloration does not disappear after two weeks, please consult a doctor.

- **Skin infections and inflammation**

Very rare. If the device is used in existing wounds and cuts (might happen when shaving the area), it can cause mentioned side effects.

- **Possible causes of excessive pain during and after the treatment**

You used the device on an area that was not shaved before you start the treatment; the flash intensity is too high for your skin tone and hair color; you used the device in the same exact area more than once; you used the device in an open wound; the area you are treating has any sort of inflammation or infection; you are using the device in areas with tattoos or sunburns.

## 7. CLEANING & MAINTENANCE

---

- ✘ After each use, use a medical disinfectant to wipe the surface of the light exit window filter, keep this area clean.
- This device is not waterproof. Do not immerse it or wash it under running water.
- Do not use steel wool, abrasive cleanser, chemicals or corrosive liquids to clean the device.

## 8. STORAGE

---

Do not place or store the device for long periods in a hot or humid environment.

## 9. RECYCLING

---

Do not dispose of this device with the household waste. Please take this device to a local recycling point for proper disposal. Proper disposal and recycling practices contribute to environmental protection.

## 10. WARRANTY & SUPPORT

- Troubleshooting

Problem	Possible Cause	Solution
The device does not emit the flash.	The power cable is not correctly connected.	Check the connection of the power supply and adjust the cable.
	The skin contact sensor is not close enough to the skin.	Re-adjust the position of the device on your skin until the ready light indicator turns green.
	The selected flash intensity level is too high.	Adjust the flash intensity according to your skin tone and hair color.
The READY indicator does not light up.	The power cable is not correctly connected.	Check the connection of the power supply and adjust the cable.
	The device skin contact sensor is not close enough to the skin.	Re-adjust the position of the device on your skin until the ready light indicator turns green.
	You did not choose a flash intensity.	Select the flash intensity as guided.
During use the device has entered standby mode.	This device features a high-temperature protection system. The protection system is always on when using the highest flash intensity level, and the device will enter standby mode if the temperature is too high (this is normal).	You can press the power button to turn on the device again.
The device produces an odd smell.	The light exit window filter is dirty.	Carefully clean the light exit window filter with a medical disinfectant.
	Hairs were not properly removed before the treatment. The flash burns the hair causing an odd smell.	Before you start using the device, remove all hairs from the area you want to treat with a razor blade or trimmer.
You feel pain when using the device.	The flash intensity is too high.	Verify the flash intensity and reduce it.
	The filter of the light exit window is damaged.	Please stop using the device and contact your <a href="http://Love-my-skin.co.uk">Love-my-skin.co.uk</a> for assistance.
	You are using the device in a non-applicable area.	Please read the instruction manual, warnings and prohibited use are mentioned.

Problem	Possible Cause	Solution
After using the device, the treated area shows signs of redness.	Mild redness is a normal and harmless reaction to the hair removal.	Do not take any action, is a normal reaction.
The treatment results are not satisfactory.	The flash intensity used is too low.	Next treatment, adjust the flash intensity.
	The frequency is lower than recommended.	In order to keep the skin smooth and without hairs, is recommended to use the device once every two weeks. Treatment intervals depend on each person hair growth cycle, do not use the device more than once every two weeks. Overusing the device increases the risk of adverse skin reactions.
	Your skin tone and hair color are not suitable to use with this device.	If your body hairs are blonde, red, gray, white, or if your skin tone is very dark, do not use this device.
Other problems.		Contact your local dealer.
Note: If the device still does not work properly after using the above solutions, please stop using the device and contact your local dealer.		

#### • After-Sales Service

Please visit our website [www.love-my-skin.co.uk](http://www.love-my-skin.co.uk) or contact our customer service team [info@lovemyskin.com](mailto:info@lovemyskin.com) if you need to learn about our products or if you need any information. You can also contact an affiliate dealer in your country.

 Model Reference



Manufacture Date

 Complies with EU requirements



“Environment Protection” – Waste electrical products should not be disposed of with household waste. Please recycle where facilities exist. Check with your local Authority or retailer for recycling advice.

Unit 3 Perrywood Business Park  
Honeycrook Lane, Redhill, RH1 5DZ UK

**+44(0)1483 937967**

**[www.love-my-skin.co.uk](http://www.love-my-skin.co.uk)**

**Made in China**

